

Development of Business Cases for Fuel Cells and Hydrogen Applications for Regions and Cities

FCH Delivery vans





This compilation of application-specific information forms part of the study ***"Development of Business Cases for Fuel Cells and Hydrogen Applications for European Regions and Cities"*** commissioned by the Fuel Cells and Hydrogen 2 Joint Undertaking (FCH2 JU), N° FCH/OP/contract 180, Reference Number FCH JU 2017 D4259 .

The study aims to **support a coalition of currently more than 90 European regions and cities** in their assessment of fuel cells and hydrogen applications to support project development. Roland Berger GmbH coordinated the study work of the coalition and provided analytical support.

All information provided within this document **is based on publically available sources** and reflects the **state of knowledge as of August 2017**.



Table of Contents

Topic	Page
A. Technology Introduction	4
B. Preliminary Business Case	9

A. Technology Introduction

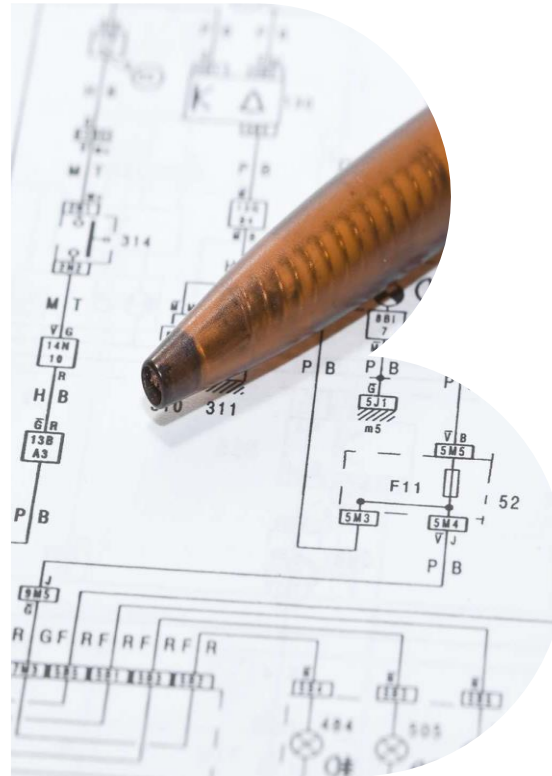

Fuel cell powered delivery vans offer a zero-emission alternative for inner-city delivery logistics, e.g. for postal and parcel services

Fuel cell electric vehicles – Delivery vans

1/4

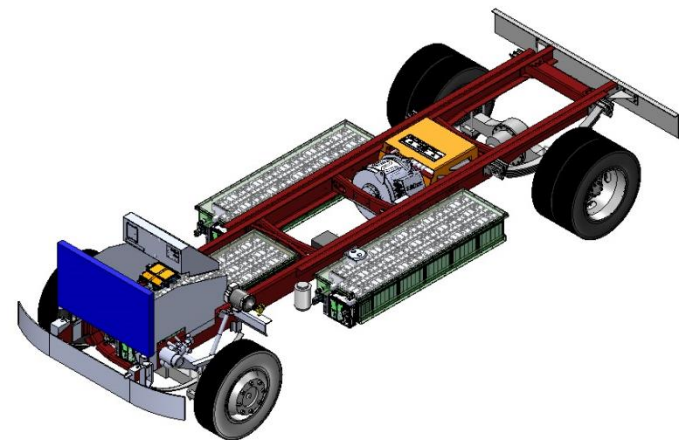

Brief description: Fuel cell electric vehicles (FCEV) delivery vans use compressed hydrogen gas as a fuel to generate electricity via an energy converter (the fuel cell) to power an electric engine – full FCH drive train; hybrid systems with battery and FCH range extenders exist as well and are currently pursued most actively

Use cases: Cities & regions can use/promote FCEV for commercial use in all kinds of inner-city delivery services, e.g. deploy FCH delivery vans for municipal dispatches in order to lower noise and air pollution as well as carbon dioxide; cities and regions can establish "environmental zones" (zero-/low-emission-zones)

Fuel cell electric vehicles (FCEV) – Delivery Vans¹⁾

Key components	Fuel cell stack, system module, hydrogen tank, battery, electric engine
Output	30-80 kW (~40-110 hp)
Top speed; range	100-130 km/h; ~200-300 km (2 times 5kg hydrogen tanks)
Fuel	Hydrogen
Battery	22-80 kWh lithium-ion battery pack
Approximate unit cost	n.a.
Original equipment manufacturers	Unique Electric Solutions, Renault/Symbio Fcell, Street Scooter
Fuel cell suppliers	Hydrogenics, PlugPower, Symbio Fcell, NuCellSys
Typical customers	Logistics companies, postal services, other delivery
Competing technologies	Gasoline or diesel combustion, EV ²⁾ (+ range extender)

1) Mainly based on two examples: Navistar International 1652SC for UPS in California and Renault Kangoo ZE H2 350b by Symbio

2) Electric Vehicle

UPS recently presented another hydrogen fuel-cell powered zero-emission delivery vehicle at ACT Expo 2017 in Long Beach, CA





Fuel cell electric vehicles – Delivery vans

2/4

Overall technological readiness: FCEV delivery vans are still in proof-of-concept phase, use cases are predominantly centered around range extension of existing battery powered vans in commercial use for last-mile deliveries



Demonstration projects / deployment examples (selection)

Project	Country	Start	Scope	Project volume
Hydrogen Mobility Europe (H2ME)		2016	H2ME brings together eight European countries to improve hydrogen refuelling infrastructure and to demonstrate feasibility of over 1,400 vans and cars in real life operations	EUR 164 m
Fuel Cell Hybrid Electric Delivery Van Project		2014	Proof-of-concept for commercial hydrogen powered delivery vehicles as well as performance and durability data collection from in-service operations of 17 fuel-cell vans in collaboration with UPS, funded by U.S. Gov. through DOE	EUR 10.3 m
HyWay ¹⁾		2014	Largest European hydrogen fleet and 2 refuelling stations to test operation of hydrogen-powered range extenders, 50 Kangoo ZE- H ₂ in service	n.a.
VULe partagé ¹⁾		2014	Commercial car sharing service in partnership with Paris town hall targeted at merchants and craftsmen; 10 Kangoo ZE-H ₂ (range extended) in service	n.a.

Products / systems available (selection)

Name	OEM	Product features	Country	Since	Cost
UPS delivery van	Unique Electric Solutions	Fuel cell powered walk-in van based on Navistar International 1652SC 4x2, 32 kW fuel cell (Hydrogenics HD30), 45 kWh LiFeMgO ₄ battery (Valence Technology) in California. Similar project of FedEx in the same region		2014	n.a.

1) Only fuel cell range extender comprised

*) Technology Readiness Level ▼ ≤ 5 ▼ 6-7 ▼ 8-9

Specific use case characteristics matched with demand and user profiles enable promising benefits, esp. on the environmental side

Fuel cell electric vehicles – Delivery vans

3/4

Use case characteristics

Stakeholders involved



- > Users (logistic carriers, merchants, craftsmen, postal services, utility providers); public authorities (vehicle approval, regulatory framework of pollutants etc.)
- > OEMs and FC manufacturers
- > H₂ suppliers and infrastructure providers

Demand and user profile



- > High vehicle uptime enabling a continuous utilisation of vehicles, including low refuelling times
- > Short but multiple driving distances due to inner-city traffic and deliveries, frequent stop-and-go

Deployment requirements



- > Network of refuelling stations along relevant delivery routes or at least at key depots
- > High safety standards for fuel cell components

Key other aspects



- > Hybrid use of fuel cell as range extension for battery powered EV vs. fuel FCH drive train
- > 200 km vehicle range will meet 97% of delivery van driving distances

Benefit potential for regions and cities

Environmental



- > Zero tailpipe emissions of pollutants (esp. NO_x) and greenhouse gases (esp. CO₂)
- > Low noise pollution (depending on speed and track conditions almost no noise emissions at all)

Social



- > Public health benefits (esp. in urban areas), overall higher standard of living
- > Lower adverse impact on residents adjacent to major inner-city logistics routes, e.g. retail pedestrian areas

Economic



- > Development of expertise in FCEV technology as potential driver of future economic growth
- > Reduction of dependency on fossil fuels or energy imports
- > Increased attraction for region or city due to FCH infrastructure

Other



- > Option to upgrade of existing battery-powered EV with fuel cell range extension
- > Potentially high public, every-day visibility as "urban" FCH use case
- > Potential to address last mile delivery in rural areas with long range requirements between refuelling cycles

Although first deployments are ongoing, further demonstration projects and additional vehicles are needed

Fuel cell electric vehicles – Delivery vans

4/4

Hot topics / critical issues / key challenges:

- > **(Commercial) vehicle availability**, currently limited to range-extended battery electric vehicles and limited flexibility for vehicle selection
- > **Current deployment** – further development of FCH delivery van prototypes and successful demonstration projects needed (still mainly in US, Europe needs to follow)
- > **Range extension**, enlargement of operation range or further development of hybrid operation with battery powered powertrain for extension
- > **Hydrogen infrastructure**, i.e. distribution logistics, local storage, refuelling stations and respective costs
- > **Well-to-Wheel emissions**, reduction potential largely depends on resources used for hydrogen production

Further recommended reading:



- > Official website of Hydrogen Mobility Europe:
<http://h2me.eu/>
- > Presentation on fuel cell hybrid electric delivery van project:
https://www.hydrogen.energy.gov/pdfs/review16/tv034_hanlin_2016_o.pdf

Key contacts in the coalition:



Please refer to working group clustering in stakeholder list on the share folder

<https://sharefolder.rolandberger.com/project/P005>

B. Preliminary Business Case



FC-hybrid/electric delivery vans fulfil many requirements operators are interested in

Advantages of FC-hybrid/electric delivery vans

- FC electric or hybrid delivery vans are 0-emission vehicles, complying with inner-city regulations on 0-emission zones. FCH delivery vans could also potentially benefit from special night-delivery permits for low-noise vehicles
- Already today, technologies for FC-hybrid/electric delivery vans demonstrate ranges sufficiently long to cover typical driving perimeters around distribution centres – and could particularly do so in longer-range use cases (suburban or rural delivery), as full FCH powertrain or range extender solutions
- Refuelling can be conducted at public H₂ refuelling stations and/or company-owned depot stations, short refuelling times minimize interruptions in the daily operating schedule
- Maintenance and fuel costs of FC-hybrid/electric delivery vans are outperforming costs of conventional diesel powertrains

Vehicles for all types of operators are available since the delivery van market covers highly heterogeneous use cases

Types of delivery vans by category and available technologies

INDICATIVE



Load bed	ca. 1,000 l	ca. 5,000 l	ca. 10,000 l	ca. 35,000 l
Exemp. Model	e.g. Renault Kangoo	e.g. VW Transporter	e.g. Mercedes Sprinter	e.g. Iveco Daily
Description – Use case (examples)	Just-in-time delivery of e.g. perishable goods or courier deliveries to close-by inner-city surroundings	Transportation and selected stock keeping of replacement parts and tools for craftsmen	Inner-city and regional delivery of parcels from distribution centres to the final customer	Regional delivery of larger parcels and bulky goods (e.g. furniture elements)
Range [per day]	30 – 150 km	30 – 150 km	30 – 350 km	30 – 250 km
Available technologies	FCEV, FC hybrid, BEV, CNG/LNG, Diesel	FCEV, FC hybrid, BEV, CNG/LNG, Diesel	FCEV, FC hybrid, BEV, CNG/LNG, Diesel	FCEV, FC hybrid, BEV, CNG/LNG, Diesel
Engine output	45 – 60 kW	50 – 150 kW	60 – 110 kW	70 – 150 kW
Consumption	Highly dependent on the individual use case, for example type of good transported, number of stops per day, rural or urban area of operation, etc.			

Already today, a variety of FC-hybrid/electric vehicle types have been prototyped successfully or are even already deployed

Status of fuel cell hybrid/electric delivery vans

Overall technological readiness: FCEV delivery vans are still in proof-of-concept phase, use cases are predominantly centred around range extension of existing battery powered vans in commercial use for last-mile deliveries

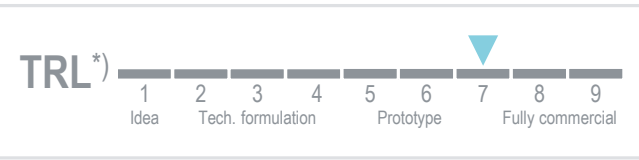

Demonstration projects / deployment examples (selection)

Project	Country	Start	Scope	Project volume
Hydrogen Mobility Europe (H2ME)		2016	H2ME brings together eight European countries to improve hydrogen refuelling infrastructure and to demonstrate feasibility of over 1,400 vans and cars in real life operations	EUR 170 m
Fuel Cell Hybrid Electric Delivery Van Project		2014	Proof-of-concept for commercial hydrogen powered delivery vehicles as well as performance and durability data collection from in-service operations of 17 fuel-cell vans in collaboration with UPS, funded by U.S. Gov. through DOE	EUR 10.3 m
HyWay ¹⁾		2014	Largest European hydrogen fleet and 2 refuelling stations to test operation of hydrogen-powered range extenders, 50 Kangoo ZE- H ₂ in service	n.a.
VULe partagé ¹⁾		2014	Commercial car sharing service in partnership with Paris town hall targeted at merchants and craftsmen; 10 Kangoo ZE-H ₂ (range extended) in service	n.a.

Products / systems available (selection)

Name	OEM	Product features	Country	Since	Cost
UPS delivery van	Unique Electric Solutions	Fuel cell powered walk-in van based on Navistar International 1652SC 4x2, 32 kW fuel cell (Hydrogenics HD30), 45 kWh LiFeMgO ₄ battery (Valence Technology) in California. Similar project of FedEx in the same region		2014	n.a.

1) Only fuel cell range extender comprised

*) Technology Readiness Level ≤ 5 6-7 8-9

Due to their superior range and refuelling times as well as their low emissions, FC-hybrid/electric vans are an attractive alternative

Average powertrain parameters for delivery vans < 3.5 t

INDICATIVE

1 FCH Delivery Truck

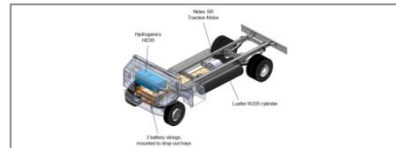



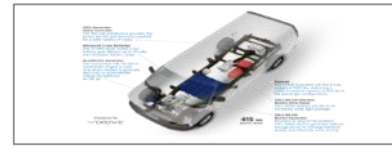

2 BE Delivery Truck

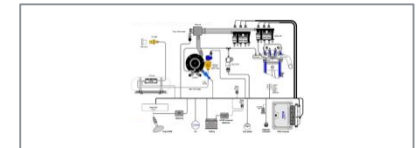

3 Diesel Delivery Truck



CAPEX [EUR]	Actual 2015	149,400-165,200	68,900-76,200	28,500-31,500
	Estimate 2030	51,300-56,800	53,300-58,900	35,600-39,500
Consumption [kWh/km]	Actual 2015	0.58-0.64	0.33-0.37	0.7-0.78
	Estimate 2030	0.49-0.55	0.29-0.32	0.58-0.64
Maintenance [EUR/km]	Actual 2015	0.23-0.25	0.09-0.1	0.09-0.1
	Estimate 2030	0.05-0.06	0.05-0.04	0.09-0.1
Refuelling time¹⁾	Low		High	
Range¹⁾	Medium-high range		Low-medium range	
Key challenges	Commercial availability (only prototypes in the market), size of hydrogen tanks for sufficient daily range without return to depot		Cost, size and weight of batteries; range restricts delivery service in less densely populated operational areas	CO ₂ and NO _x emissions and related regulation as well as noise pollution, particularly in the inner city operational areas
TRL level	Level 6 - 7		Level 8 - 9	Level 9

1) Expected, still being tested and under constant development

However, FC delivery vans need a competitive advantage on OPEX in order to benchmark well against the powertrain competition

Schematic outline of TCO for FC delivery vans and its drivers – SIMPLIFIED, INDICATIVE

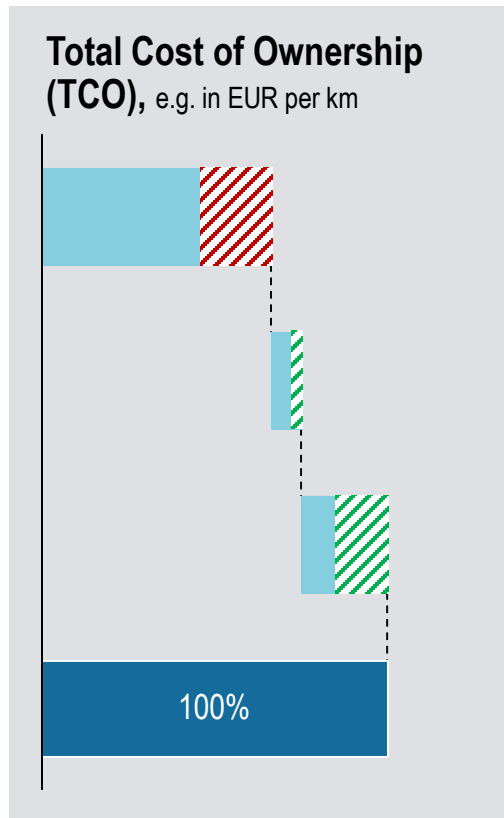

	Diesel	Battery electric	Fuel cell
Capital cost	<ul style="list-style-type: none"> > Lower price per kW power > Maturity level reached, low development costs > Conventional fossil fuel refuelling stations can be used 	<ul style="list-style-type: none"> > Higher costs per kW > High development costs starting to decrease due to increasing production > High investments in company owned recharging stations or reliance on public stations 	<ul style="list-style-type: none"> > Highest costs per kW > Highest development and permitting costs > High investments in company owned refuelling stations or reliance on public stations
Op's & maint. cost	<ul style="list-style-type: none"> > High maintenance costs > Less expensive spare parts 	<ul style="list-style-type: none"> > Frequent maintenance routine for batteries necessary > Moderately priced spare parts 	<ul style="list-style-type: none"> > Less frequent maintenance routine, lower maintenance costs > More expensive spare parts
Fuel cost	<ul style="list-style-type: none"> > Highest fuel costs per km > Higher maintenance cost 	<ul style="list-style-type: none"> > Lowest fuel costs per km > Low carbon footprint 	<ul style="list-style-type: none"> > Low fuel costs per km, potentially further decreasing over time > Low carbon footprint

Take-away → Currently, high capital costs make fuel cells the more expensive alternative. However, further improvements in production and fuel price reductions can lead to a superior cost position in comparison to combustion engines and battery electric vehicles in the future. Focus on longer-range use cases and possibly range-extender solutions might be warranted

/// Additional cost range for alternative powertrains // Range for additional savings through alternative powertrains

Currently, fuel cell delivery vans are the cleanest option amongst the competing technologies but BE delivery vans are set to catch up

WTW emissions benchmarking

INDICATIVE

Benchmarking "CURRENT"

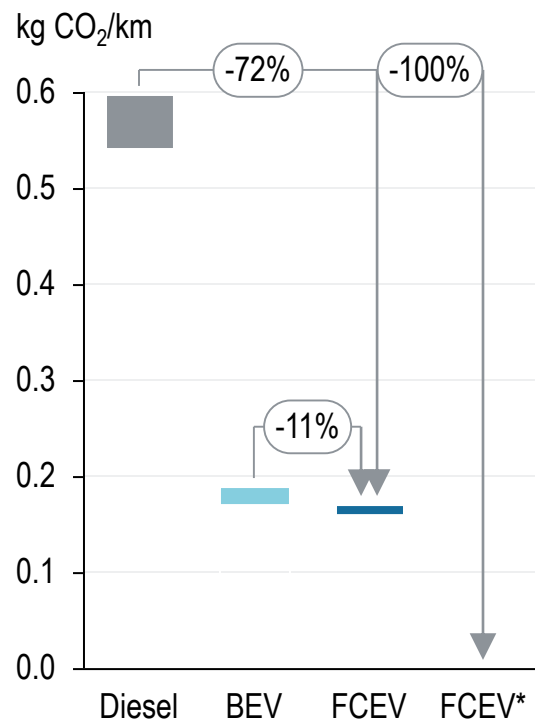

Benchmarking "POTENTIAL"

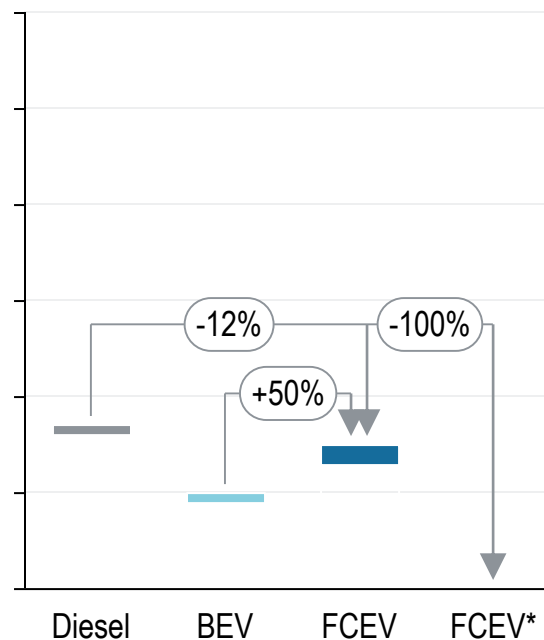

> Key drivers:

- Availability of green hydrogen is decisive in outperforming the benchmark technologies
- Development of the energy mix highly determines the environmental competitiveness of FCE delivery vans vs. BE vans

> Underlying assumptions:

- CO₂ intensity of "grey" hydrogen: 9.00 kg / kg H₂
- CO₂ intensity of diesel: 2.64 kg/l
- CO₂ intensity of electricity: 0.51 / 0.30 kg/kWh (the BEV's CO₂ advantages depend on the development of the energy mix in Europe and the assumption that range issues will be overcome)

*) Green hydrogen

BEVs for now take most of the early conversion markets for urban last-mile delivery; FCs see potential in longer-range use cases

Immediate implications for Regions & Cities in the short term

- Until now, battery electric delivery vans already capture parts of the 0-emission conversion opportunities for urban/suburban last-mile delivery vans (~100 km/d range, e.g. "Streetscooter" in Germany), benefitting from cost and performance improvements of BEVs overall; FCH vehicles might better focus on **longer-range use cases** (e.g. rural delivery services) or **special purpose vehicles with extra energy needs** such as delivery vans with permanent cooling either as full powertrain or as range extender solutions. In such uses cases, larger batteries might reduce the payload of the vehicle. Non-powertrain related disruptions are another key determinant of future vehicle market volumes
- **Short-term opportunities and immediate implications for Regions & Cities:**
 - > Map local stakeholders and discuss potential FC delivery van applications – support the development of interest groups and demonstration projects
 - > Incorporate battery and FC range extenders into potential portfolio of alternatives to increase the applicability of fuel cells
 - > Closely monitor developments in the various demonstration projects across Europe in alignment with interested regional stakeholders
 - > Think or Re-Think the hydrogen infrastructure roll-out strategy depending on potential needs of FC-electric/hybrid delivery vans in the region

Please do not hesitate to get in touch with us

Contact information



Carlos Navas
FCH2 JU

Strategy and Market Development Officer

carlos.navas@fch.europa.eu

+32 2 221 81 37